

2010

*Newsteo SAS
Zone Athélia IV
93 Avenue des Sorbiers
F-13600 LA CIOTAT
Tel-Fax : +33 (0)4 42 01 82 23
www.newsteo.com*



PRODUCT CATALOGUE

SUMMARY





<i>LOG Loggers</i>	3
<i>LGR Loggers</i>	4
<i>LGR Probes</i>	5
<i>LGR cable and connector</i>	6
<i>LGS Loggers</i>	7
<i>LGS probes and cables (LGS31 excepted)</i>	8
<i>LGS31 probes and cables</i>	9
<i>LGW Loggers</i>	10
<i>LGW probes and cables</i>	10
<i>TRK Trackers</i>	11
<i>BLR Builders</i>	11
<i>RPT Repeaters</i>	12
<i>KEY</i>	12
<i>Tags & Localizators</i>	13
<i>Software</i>	14
<i>Antennas for NEWSTEO products</i>	15
<i>Evaluation kits for NEWSTEO products</i>	16
<i>Accessories</i>	18

Abbreviations

LT : Lithium Thionyle

Please notice that our products can be certified (COFRAC) on request. Contact us for a quotation.

LOG Loggers

Reference	Sensor(s)	Case	Battery	Antenna	Picture
PFPN-LOG11-001	Temp. \pm 0.6°C	IP54*	1/2 AA (LT)	Internal	
PFPN-LOG16-001	Temp. \pm 0.3°C	IP54*	1/2 AA (LT)	Internal	
PFPN-LOG21-001	Temp. \pm 0.6°C	IP54*	1/2 AA (LT)	¼ wavelength	
PFPN-LOG26-001	Temp. \pm 0.3°C	IP54*	1/2 AA (LT)	¼ wavelength	
PFPN-LOG31-001	Temp. \pm 0.6°C	IP65	AA (LT)	½ wavelength	
PFPN-LOG36-001	Temp. \pm 0.3°C	IP65	AA (LT)	½ wavelength	
PFPN-LOG20-001	Temp. \pm 0.5°C Hum. \pm 4.5%	IP54*	1/2 AA (LT)	¼ wavelength	
PFPN-LOG22-001	Temp. \pm 0.4°C Hum. \pm 3%	IP54*	1/2 AA (LT)	¼ wavelength	
PFPN-LOG25-001	Temp. \pm 0.3°C Hum. \pm 2%	IP54*	1/2 AA (LT)	¼ wavelength	

* Non condensed area

LT : Lithium Thionyle









LGR Loggers





Reference	Interface	Case	Battery	Antenna	Picture
PFPN-LGR30-001	For PT100	IP65 Aluminium	AA (LT)	½ wavelength	
PFPN-LGR32-001	For Temp & Hum sensor	IP65 Aluminium	AA (LT)	½ wavelength	
PFPN-LGR33-001	For PT1000	IP65 Aluminium	AA (LT)	½ wavelength	
PFPN-LGR36-001	For Temp sensor	IP65 Aluminium	AA (LT)	½ wavelength	
PFPN-LGR37-001	For Thermocouple	IP65 Aluminium	AA (LT)	½ wavelength	
PFPN-LGR46-001	Double external probe of temperature Temp. ± 0.3°C	IP65 Aluminium	AA (LT)	½ wavelength	

LT : Lithium Thionyle



Reference	Integrated sensor	Case	Battery	Antenna	Picture
PFPN-LGR52-001	Temp. ± 0.4°C Hum. ± 3%	IP65	AA (LT)	½ wavelength	
PFPN-LRG55-001	Temp. ± 0.3°C Hum. ± 2%	IP65	AA (LT)	½ wavelength	

LGR Probes

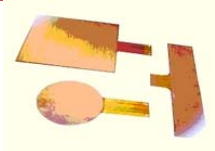
Reference	Sensor	Compliant with	IP	Characteristics	Picture
PFPN-STE52-001	PT100 -40 to 60°C	PFPN-LGR30	IP68	End protected by a heat-shrinkable sleeve	
PFPN-STE52-002	PT100 -50 to 250°C	PFPN-LGR30	IP68	PT100 for food contact	
PFPN-STE52-003	PT 100 -50 to 250°C	PFPN-LGR30	IP68	Straight PT100 end of 150 mm	
PFPN-STE53-001	PT1000 -40 to 60°C	PFPN-LGR33	IP68	End protected by a heat-shrinkable sleeve	
PFPN-STE53-002	PT1000 -40 to 500°C	PFPN-LGR33	IP68	Probe of stainless steel of 20mm	
PFPN-STE53-003	PT1000 -50 to 180°C	PFPN-LGR33	IP68	Probe of stainless steel of 100mm	
PFPN-STE51-001	Temp. $\pm 0.3^{\circ}\text{C}$ -25 to 60°C $\pm 0.3^{\circ}\text{C}$	PFPN-LGR36	IP68	Integrated temperature sensor	
PFPN-STE51-002	Temp. $\pm 0.3^{\circ}\text{C}$ -25 to 100°C	PFPN-LGR36	IP68	Integrated temperature sensor	
PFPN-STT51-001	Temp. $\pm 0.3^{\circ}\text{C}$ -25 to 100°C	PFPN-LGR46	IP68	Dual temperature probe	

Reference	Sensor	Compliant with	IP	Characteristics	Picture
PFPN-STH51-001	-25 to 80°C Temp. ± 0.4°C Hum. ± 3.0%	PFPN-LGR32	IP65		
PFPN-STH55-001	-25 to 80°C Temp. ± 0.3°C Hum. ± 2.0%	PFPN-LGR32	IP65		
PFPN-STH50-003	- 40 ... +125 °C Temp. ±0.3°C Hum. ± 2.8%	PFPN-LGR32		Stainless steel	
PFPN-STCO1-001	thermocouple type K -40 to 1100°C	LGR37-001	IP68	Thermocouple type K with probe of 150 mm	
PFPN-STCO1-002	thermocouple type K -100 to 1100°C	LGR37-001	IP68	Thermocouple K cold temperature probe	
PFPN-STF51-001	Thermal Flux	LGR37-001		Probe Thermal Flux 50x50mm	

LGR cable and connector

Reference	Type	Compliant with	IP	Characteristics	Picture
PFPN-CON05-001	Connector	LGR37	IP65	To connect any thermocouple (K, E, J, N, T)	
PFPN-SES55-001	Cable	Any LGR except thermocouple	IP65	5 meters cable Provided with fast contactors	



*If you want to use your own sensor, you have to order a cable and a connector to plug it on the LGR.

LGS Loggers

Reference	Interface	Case	Battery	Antenna	Picture
PFPN-LGS31-001	Potentiometer	IP65	AA LT	½ wavelength	
PFPN-LGS32-001	Potentiometer (100 to 5KΩ)	IP65	AA LT	½ wavelength	
PFPN-LGS34-001	4-20mA	IP65	AA LT	½ wavelength	
PFPN-LGS35-001	0-10V	IP65	AA LT	½ wavelength	
PFPN-LGS36-001	On/Off input	IP65	AA LT	½ wavelength	
PFPN-LGS37-001	-50/+50mV	IP65	AA LT	½ wavelength	
PFPN-LGS38-001	Connection of 3 strain gauges	IP65	AA LT	½ wavelength	
PFPN-LGS39-001	Impulse	IP65	AA LT	½ wavelength	
PFPN-LGSA9-001	Impulse ATEX zone 2 gas certified	IP65	AA LT	½ wavelength	
PFPN-LGS3A-001	Strain gauges (Wheatstone bridge)	IP65	AA LT	½ wavelength	







LT : Lithium Thionyle

LGS probes and cables (LGS31 excepted)

Reference	Type	Compliant with	IP	Characteristics	picture
PFPN-STJ58-002	Cable	PFPN-LGS38-001	IP65	Cable to weld 3 gauges, with integrated temperature sensor	
PFPN-JAUGE-001	Probe	PFPN-LGS38-001	IP00	Strain gauge to be welded on STJ58-001	
PFPN-SES55-001	Cable	LGS34-001 LGS35-001 LGS37-001 LGS39-001 LGS36-001	IP65	5 meters cable, to connect any sensor, provided with fast contactors	
PFPN-CON05-001	Connector	LGS34-001 LGS35-001 LGS37-001 LGS39-001 LGS36-001	IP65	To directly connect the customer sensor to the LGS.	

*If you want to use your own sensor, you have to order a cable and a connector to plug it on the LGR.

LGS31 probes and cables



Reference	Type	Compliant with	IP	Characteristics	picture
PFPN-FISSU-001	Crackmeter	LGS31-001 + STY58-002	IP40	Measurement bracket: 10... 100 mm	
PFPN-STY58-002	Associated cable	LGS31-001	IP40	5 meters with temperature gauge integrated and connector for FISSU-001	
PFPN-FISSU-002	Crackmeter	LGS31-001 + STY58-003	IP67	Measurement bracket: 25...300 mm	
PFPN-STY58-003	Associated cable	LGS31-001	IP67	5 meters with temperature gauge integrated and connector for FISSU-002	
PFPN-FISSU-003	Crackmeter	LGS31-001	IP67	Gefran PCM050 crackmeter, female connector	
PFPN-STY58-004	Associated cable	LGS31-001	IP67	Temperature probe with "Y" Extender with connector	
PFPN-SES58-001	Cable	LGS31-001	IP65	5 meters cable, to connect any sensor, provided with fast contactors	
PFPN-STY58-001	Cable	LGS31-001	IP65	5 meters cable, to connect any sensor, provided with fast contactors and temperature sensor	

LGW Loggers

Reference	Characteristics	Case	Battery	Antenna	Picture
PFPN-LGW31-001	Power supply of the sensor in 3V	IP65	AA LT	½ wavelength	
PFPN-LGW32-001	Power supply of the sensor in 10V	IP65	AA LT	½ wavelength	
PFPN-LGW33-001	Power supply of the sensor in 12V	IP65	AA LT	½ wavelength	
PFPN-LGW38-001	Power supply of the sensor in 10V	IP65	AA LT	½ wavelength	



LT : Lithium Thionyle

LGW probes and cables

Reference	Type	Adaptable to the LGS :	IP	Characteristics	Picture
PFPN-PYRAN-001	Probe	LGW31-001	IP67	Probe of 5 meters with Pyranometer integrated	
PFPN-AIRSP-001	Probe	LGW38-001	IP20	Probe of 5 meters for speed of air measure	
PFPN-SES55-001	Cable	LGW31-001 LGW38-001	IP65	5m cable, to connect any sensor, provided with fast contactors	

*If you want to use your own sensor, you have to order a cable and a connector to plug it on the LGR.

TRK Trackers

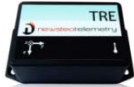
Reference	Characteristics	Case	Battery	Antenna	Picture
PFPN-TRK31-001		IP54	3 AA Alkaline	Internal	
PFPN-TRK33-001	Shock : ± 6g	IP54	A LT	Internal	
PFPN-TRK41-001	Temp. ± 0.4°C Hum. ± 3.0%	IP54	3 AA Alkaline	¼ wavelength	
PFPN-TRE52-001	Shock: 16g Temp. ± 0.3°C	IP54	C LT	Internal	



LT : Lithium Thionyle

BLR Builders





Reference	Characteristics	Case	Battery	Antenna	Picture
PFPN-BLR36-001	Temp. ± 0.3°C	IP68	D LT	High range antenna with a 5meter cable	
PFPN-BLR37-001	Temp. ± 0.3°C Deformation ±1%	IP68	D LT	High range antenna with a 5meter cable	

LT : Lithium Thionyle



RPT Repeaters

Reference	Characteristics	Case	Power supply	Antenna	Picture
PFPN-RPT41-001	Outdoor radio relay	IP67	Solar panels	Full wavelength.	
PFPN-RPT20-001	Indoor Radio relay	IP50	Conventional AC power	½ wavelength	
PFPN-RPT30-001	Outdoor radio relay	IP 65	Conventional AC power	½ wavelength	
PFPN-RPT30-002	Outdoor radio relay	IP 65	Conventional AC power	Without antenna (SMA connector)	

KEY for PC

Reference	Link	Software	IP	Antenna	Picture
PFPN-KEY11-001	RF to USB	Not provided	IP30	¼ wavelength	
PFPN-KEY11-002	RF to USB	Not provided	IP30	Without antenna	
PFPN-KEY10-001	RF to USB	Not provided	IP30	Internal	
PFPN-KEY43-001	RF to RS232		IP30	1/2 wavelength	
PFPN-KEY43-002	RF to RS232		IP30	Without antenna	
PFPN-KEY12-001	RF to USB	With RFM20 Gold	IP30	¼ wavelength	
PFPN-KEY13-001	RF to USB	Premium+CRF21 licence	IP30	¼ wavelength	
PFPN-KEY14-001	RF to USB	Gold+CRF21 licence	IP30	¼ wavelength	

KEY for PLC

Reference	Link	Software	IP	Antenna	Picture
PFPN-KES63-001	RF to RS232	Not provided	IP30	Without antenna	
PFPN-KES65-001	RF to RS485	Not provided	IP30	Without antenna	
PFPN-KES83-001	RF to RS232	Not provided	IP65	Without antenna	
PFPN-KES85-001	RF to RS485	Not provided	IP65	Without antenna	





Tags & Localizers

Reference	Type	Characteristics	Battery	IP	Antenna	Picture
PFPN-TOK01-001	TAGS	Miniature Tag without casing	CR2450	IP00	Loop	
PFPN-TAG10-001	TAGS	Miniature Tag (one time use)	1/2 AA	IP68	Loop	
PFPN-LOC40-001	Localizator	To detect fixed Balises	D	IP65	1/2 wavelength	
PFPN-LOC4A-002	Localizator	To detect fixed Balises - WITH Accelerometer	D	IP65	1/2 wavelength	
PFPN-BAL20-001	Balises for localization	To be seen by Localizators (to position on a fix place)	1/2 AA	IP30	Loop	
PFPN-BAL40-002	Balises for localization	To be seen by Localizators (to position on a fix place)	D	IP30	Loop	

Software

Reference	Link	Characteristics	Picture
PFPN-RFM10-001	RF to USB	RF Monitor with Premium license Delivered with KEY11-001 <i>Premium : The measurements are stored on the PC, on a local database</i>	
PFPN-RFM20-001	RF to USB	RF Monitor with Gold license Delivered with KEY12-001 <i>Gold : The measurements are stored on a shared and remoted database</i>	
PFPN-RFM19-001	RF to USB	Upgrade Premium to Gold license Delivered with KEY12-001	
PFPN-RFM30-001	RF to USB	RFM Gold special with CFR21	
PFPN-RFM40-001	RF to USB	RFM Premium with CFR21	

Antennas for NEWSTEO products







Reference	Type	Picture	Compatibility
PFPN-ANT40-001	Whip 1/4 wavelength		KEY LOG TRK41
PFPN-ANT41-001	Antenna 1/4 wavelength with ground plane Cable of 2 meters		KEY LOG LGR LGS
PFPN-ANT20-001	Antenna Whip 1/2 wavelength, rigid		LGR LGS LGW RPT20
PFPN-ANT20-002	Antenna Whip 1/2 wavelength, flexible		LOG KEY
PFPN-ANT11-001	Full wavelength grounded Cable of 5 meters		KEY LOG LGR LGS RPT
PFPN-ANT97-001	Yagi Directional range.		RPT (consult us)
PFPN-ANT42-001	Whip 1/4 wavelength magnetic, mobile - big foot		
PFPN-ANT12-001	Full wavelength magnetic, mobile - big foot		
PFPN-ANT43-001	Whip 1/4 wavelength magnetic - small foot		
PFPN-ANT43-001	Whip 1/4 wavelength – 0 to 90° rotation		
PFPN-ANT83-001	Whip 1/8 wavelength magnetic - small foot		





Evaluation kits for NEWSTEO products

Reference	Composition	Picture
PFKI-LOG26-001	<ul style="list-style-type: none"> - One LOG26-001 - One RFM10-001 - One KEY11-001 - One AIMANT-001 - One CBUSB-001 	
PFKI-LOG22-001	<ul style="list-style-type: none"> - One LOG22-001 - One RFM10-001 - One KEY11-001 - One AIMANT-001 - One CBUSB-001 	
PFKI-LGR33-001	<ul style="list-style-type: none"> - One LOG33-001 - One STE53-001 - One RFM10-001 - One KEY11-001 - One AIMANT-001 - One CBUSB-001 	
PFKI-LGR37-001	<ul style="list-style-type: none"> - One LOG37-001 - One STC01-001 - One RFM10-001 - One KEY11-001 - One AIMANT-001 - One CBUSB-001 	
PFKI-TRK31-001	<ul style="list-style-type: none"> - One TRK31-001 - One RFM10-001 - One KEY11-001 - One CBUSB-001 	
PFKI-BLR37-001	<ul style="list-style-type: none"> - One BLR37-001 - One RFM10-001 - One KEY11-001 - One CBUSB-001 	

Reference	Composition	Picture
PFKI-LGS34-001	<ul style="list-style-type: none"> - One LGS34-001 - One SES55-001 - One RFM10-001 - One KEY11-001 - One AIMANT-001 - One CBUSB-001 	
PFKI-LGS35-001	<ul style="list-style-type: none"> - One LGS35-001 - One SES55-001 - One RFM10-001 - One KEY11-001 - One AIMANT-001 - One CBUSB-001 	
PFKI-LGS31-002	<ul style="list-style-type: none"> - One LGS31-001 - One STY58-002 - One FISSU-001 - One RFM10-001 - One KEY11-001 - One AIMANT-001 - One CBUSB-001 	
PFKI-LGS39-001	<ul style="list-style-type: none"> - One LGS39-001 - One SES55-001 - One RFM10-001 - One KEY11-001 - One AIMANT-001 - One CBUSB-001 	

Accessories

Reference	Accessory	Characteristics	Picture
PFPN-CBL05-001	Cable	5m extension coax cable SMA Male-Female	
PFPN-CBL10-001	Cable	10m extension coax cable SMA Male-Female	
PFPN-CBL20-001	Cable	20m extension coax cable SMA Male-Female	
PFPN-CBL05-002	Cable	5m extension coax cable SMA Male to N female	
PFPN-CBL10-002	Cable	10m extension coax cable SMA Male to N female	
PFPN-CPPMM-001	Cable	Thru-wall adapter (dual male-male SMA connector)	
PFPN-CPPMF-001	Cable	Thru-wall male SMA for screwed antenna (+ fem. SMA 20 cm extender)	
PFPN-CDRFM-001	CD-ROM	Additional RFM-10 CD ROM installer	
PFPN-CDRFM-002	CD-ROM	Additional RFM-20 CD ROM installer	
PFPN-CDRFM-003	CD-ROM	Additional RFM-19 CD ROM installer	
PFPN-CDLOC-001	CD-ROM	Additional RFM with Localization CD ROM installer	
PFPN-LOTPI-001	Battery	Lot of 10 lithium thyonil 1/2 AA batteries	 SIZE/ANSI: 1/2AA, ER14252
PFPN-LOTPI-002	Battery	Lot of 10 lithium thyonil AA batteries	 SIZE/ANSI : AA, ER14505
PFPN-LOTPI-003	Battery	Lot of 10 lithium thyonil A batteries	
PFPN-LOTPI-004	Battery	Lot of 10 lithium thyonil C batteries	 SIZE/ANSI : C, ER26500
PFPN-LOTPI-005	Battery	Lot of 10 lithium thyonil D batteries	 SIZE/ANSI : D, ER32L615

PFPN-LOTPI-006	Battery	Lot of 10 lithium CR2450 batteries	
PFPN-BRG21-001	USB bridge	hardware bridge between USB and RS232 ports	
PFPN-BRG32-001	USB bridge	hardware bridge between USB and Ethernet	
PFKI-CLEAN-001	cleaning tools	Special cleaning tools to prepare surface	
PFPN-AIMANT-001	Magnet	Newsteo magnet to wake-up loggers	
PFPN-CBUSB-001	Cable USB	USB-A Male-Female extender cable 0.8m	
PFPN-CBUSB-002	Cable USB	USB-A Male to Male Mini USB cable 2m	
PFPN-CBUSB-003	Cable USB	USB-A Male to Male Micro USB cable 1m	
PFPN-RLB21-001	USB output relay	3 relay contacts	
PFPN-RLBW2-001	USB output relay	2x3 relay contacts	